



**KANDI**

**COWBOY E10K ELECTRIC UTV**

# **OWNER'S MANUAL**



[www.KandiAmerica.com](http://www.KandiAmerica.com)

# OWNER'S MANUAL



## WARNING

Before operating this vehicle, carefully read this manual and any owner's manual supplements.

**THIS VEHICLE IS NOT INTENDED FOR USE ON RENTAL TRACKS OR FOR RACING.**

## Kandi Cowboy e10K Electric UTV

**Before operating this vehicle, the owner and anyone permitted to operate the vehicle must read and understand all instructions for safe operation of the vehicle, as specified in this owner's manual.**



Kandi America

8050 Forest Lane, Dallas, TX 75243

Phone: (972) 271-0888

Email: [support@kandiamerica.com](mailto:support@kandiamerica.com)

### NOTE:

Please keep this manual in an easily accessible location so that it can be found and referenced when needed.

# CONTENTS

1. Introduction .....	6
1.1 Important Safety Notices .....	7
1.2 Understanding Safety Warnings.....	8
1.3 Safety Alert Symbols .....	9
1.4 Operating Procedures .....	10
2. Vehicle Warning Decals .....	14
3. Vehicle Safety Alerts .....	20
4. Vehicle Identification Number (VIN).....	28
5. Vehicle Display .....	29
5.1 Instrument Panel Diagram.....	29
5.2 Instrument Panel Indicators.....	30
5.3 Battery and Motor Status.....	32
5.4 Charging Screen .....	33
5.5 Setting the Clock .....	33
6. Vehicle Controls & Parts .....	37
6.1 One-Click Start.....	37
6.2 Control Switch Diagram.....	37
6.3 Control Switch Details .....	38
1. Gear switch.....	38
2. Turn signal switch .....	38
3. Headlight switch .....	38
4. Cargo bed switch.....	39
5. Winch switch.....	39
6. Hazard warning light switch .....	39
6.4 USB Charging Ports.....	39

6.5 Horn Switch.....	39
6.6 Fuse Box.....	40
6.7 Charging Socket.....	40
6.8 Pedals .....	41
1. Parking Brake Pedal.....	41
2. Brake Pedal.....	41
3. Accelerator Pedal .....	41
6.9 Seat Belts.....	42
Proper Use of the Seat Belt.....	42
7. Safety Gear.....	43
7.1 Helmets.....	43
7.2 Eye Protection.....	43
7.3 Gloves.....	43
7.4 Boots.....	43
7.5 Clothing.....	43
8. Breaking-in a New Vehicle.....	44
9. Driving the Vehicle .....	45
9.1 Startup.....	45
9.2 Start Driving .....	46
9.3 Driving Up Hills.....	46
9.4 Driving Down Hills .....	47
9.5 Skidding or Sliding .....	48
9.6 Driving Across Water.....	48
9.7 Brake Check.....	48
9.8 Driving in Cold Weather .....	49
9.9 Loading Guide.....	50
9.10 Accessories .....	50

10. Battery .....	51
10.1 Examining the Batteries .....	51
10.2 Avoiding Short Circuits .....	52
10.3 Charging the Vehicle .....	52
Charging Procedures.....	53
Charging Cable Safety Information.....	53
10.4 12V Starting Battery .....	55
Maintaining the 12V Starting Battery .....	55
Charging the 12V Starting Battery .....	55
10.5 Lithium Iron Phosphate (LiFePO <sub>4</sub> ) Batteries.....	56
11. Maintenance .....	58
11.1 Pre-ride Inspection .....	59
11.2 Periodic Maintenance .....	62
11.3 Periodic Maintenance Schedule .....	63
11.4 Periodic Maintenance Record .....	64
11.5 Gearbox Oil .....	67
Gearbox Oil Replacement .....	67
11.6 Brakes .....	69
Brake Fluid .....	69
Brake Pads .....	70
11.7 Tires.....	70
11.8 Storage.....	71
11.9 Resuming Use of the Vehicle .....	72
12. Cleaning the Vehicle .....	73
12.1 Exterior Body Panels.....	73
12.2 Seats and Floorboard.....	73
12.3 Wheels and Tires .....	73

13. Transporting the Vehicle .....	74
13.1 Strap Down the Roof .....	74
13.2 Protect the Windshield .....	74
14. Troubleshooting .....	75
14.1 Contacting an Authorized Dealer or Service Center .....	75
14.2 Battery (12V) Troubleshooting.....	75
Replacing the 12V Battery .....	76
Vehicle Specifications .....	77

## 1. Introduction

Congratulations on the purchase of your Kandi Cowboy e10K Electric UTV. We take pride in offering you a product that is engineered and manufactured to the highest performance and quality standards. We are certain that you will enjoy its superior levels of performance, reliability, riding comfort, and safety.

This manual is provided to help owners and drivers become familiar with the operation of this vehicle and with its many features. This manual also covers information on the care and maintenance of your vehicle.

Please read this manual carefully. The information contained in this owner's manual, and the warning labels on the vehicle will help you to understand the safe use and maintenance of your vehicle. Make sure that you understand and follow all warnings and instructions.

If you did not receive any of the material listed above, please call your dealer to request a copy of these materials.

Product features and specifications are subject to change without notice.

For customer service, please email [support@kandiamerica.com](mailto:support@kandiamerica.com).

## 1.1 Important Safety Notices

This vehicle is designed and manufactured for off-road use only. It is illegal to operate this vehicle on any public street, road, or highway. Such use is prohibited by law, unless otherwise provided for by the local government.

Consult applicable laws and regulations before choosing a location to operate this vehicle. It is illegal to operate this vehicle on public lands where vehicles of this size are prohibited.

**DO NOT** modify the motor, drive system, mechanical or electrical systems of this vehicle. **DO NOT** install aftermarket parts or accessories intended to increase the speed or power of this vehicle.

Failure to follow these warnings will void the warranty on this vehicle and could result in **SERIOUS INJURY** or **DEATH**.

The addition and use of certain accessories including, but not limited to, mowers, blades, sprayers, winches, and windshields will change the handling characteristics and the performance of this vehicle.

### Practice Responsible Vehicle Operation

Ensure that you understand and comply with all applicable local, state, province, federal, and national laws and requirements.

Remember to respect your vehicle, respect the environment, and respect the property of others. When operating this vehicle, you are responsible for your own safety and the safety of others around you.

**The Cowboy e10K can be hazardous to operate.**

Off-road UTV's handle differently from other vehicles such as motorcycles, ATVs, and cars. If proper precautions are not taken, rollover can occur even during routine maneuvers such as turning, driving, or turning while on a hill, or driving over an obstacle.

**1.2 Understanding Safety Warnings****ATTENTION:**

This vehicle is only intended for use by responsible individuals who are over 16 years of age. This vehicle is not a toy.

**READ AND UNDERSTAND THE OWNER'S MANUAL AND ALL WARNINGS BEFORE ATTEMPTING TO OPERATE THIS VEHICLE.**

**WARNING**

Drivers must ensure that they fully understand this vehicle before attempting to operate it.

Drivers **must** read this manual thoroughly and reference the parts of the vehicle that are under discussion in each section. Operating this vehicle carries a responsibility for ensuring your own personal safety, the safety of others, and the protection of our environment.

**NOTE:** Illustrations used in this manual are intended for reference only. Features on the vehicle are subject to change at any time without warning.

### 1.3 Safety Alert Symbols

Safety alerts identify special instructions or procedures which, if not correctly followed, could result in personal injury, or loss of life. In order to remain safe, owners and drivers must read all safety alerts in this manual carefully.



This is the safety alert symbol. When this symbol is present on the vehicle or in this owner's manual, it signals the potential for personal injury. **Pay attention. Your safety and the safety of others is at stake.**

"WARNING" indicates a potential hazard that could result in serious injury or death:



"CAUTION" indicates a potential hazard that could result in minor personal injury or damage to the vehicle:



**NOTE:** In this owner's manual, the word "NOTE" highlights key information and instructions.

**NOTE:** Warning decals have been placed on the vehicle for your protection. Read and follow the instructions on each decal carefully. In the event any decal becomes illegible or becomes detached from the vehicle, contact your dealer to order a replacement.

## 1.4 Operating Procedures



### WARNING

Ignoring the following instructions could result in serious injury or death.

Ensure that all drivers carefully read this owner's manual and all product labels and follow the operating procedures.

1. This vehicle is designed to carry a maximum of 1 driver and 1 passenger. **Do not** operate this vehicle with more than 1 passenger.
2. The driver and all passengers **must** wear seat belts while the vehicle is in motion.
3. **Do not** allow persons under 16 years of age to operate this vehicle.
4. Before permitting a guest to operate this vehicle, ensure that the guest has read this owner's manual and all product labels.
5. For their own personal safety, the driver and all passengers **must** wear Department of Transportation (DOT) approved off-road motorcycle helmets that fit properly, eye protection (glasses or face shield), gloves, boots, a long-sleeved shirt or jacket, and long pants.
6. As with any off-road-capable vehicle, there is a risk of rollover under certain conditions. The risk of rollover can be increased by uneven terrain or slopes that pitch the vehicle sideways, by turning too fast or sharply, or by a combination of these conditions.
7. Persons inside the vehicle while it is rolling over **must** keep their arms and legs inside the vehicle and **must not** attempt to use their arms or legs to stop the vehicle from rolling over, as doing so could lead to serious injury. Hands, arms, legs, and feet can easily be crushed by the vehicle. Arms and legs must be kept inside the vehicle until it comes to a complete stop.
8. The driver **must not** consume alcohol or drugs before or while operating this vehicle.

9. **Do not** drive this vehicle at excessive speeds. The driver must always operate the vehicle at a speed that is suitable for their level of experience, the terrain, visibility, and operating conditions.
10. **Do not** attempt wheelies, jumps or any other stunts with this vehicle.
11. Drivers **must** always conduct a pre-trip inspection on the vehicle to make sure it is in safe operating condition. Make sure to follow the maintenance schedule, and the inspection and maintenance procedures described in this manual.
12. Keep hands, arms, feet, and legs inside the vehicle and feet on the floorboard **at all times** while the vehicle is in motion. Use the grab handle inside the vehicle when necessary. **Do not** hold onto the exterior of the vehicle. Hands holding onto the exterior of the vehicle can easily be crushed between the vehicle and an outside obstruction.
13. Drivers **must** keep both hands on the steering wheel when driving.
14. Drivers **must not** wrap their thumbs around the steering wheel. The steering wheel should be held with thumbs pointing up. This is particularly important when driving in rough terrain, as the front wheels will travel side to side as they respond to the terrain, and this movement will be felt in the steering wheel. A sudden jolt could wrench the steering wheel, and serious injury could occur.
15. When operating this vehicle on unfamiliar terrain, drivers **must** operate the vehicle slowly and exercise extra caution.
16. Stay aware of changing terrain conditions when operating this vehicle. **Do not** operate this vehicle on excessively rough, slippery, or loose terrain.
17. If this vehicle is involved in an accident, it **must** be inspected and serviced by an authorized dealer.
18. **Do not** operate this vehicle on hills that exceed the driver's ability to navigate or are too steep for the vehicle. Practice on smaller hills before attempting to operate this vehicle on larger hills.

19. Drivers **must** follow proper procedures for climbing hills as described in this manual. **Always** check the terrain carefully before attempting to ascend any hill. **Do not** attempt to ascend hills that have excessively slippery or loose surfaces. **Do not** accelerate suddenly or make sudden gear changes. **Do not** drive over the top of any hill at high speeds.
20. Drivers **must** follow proper procedures for descending and braking on hills, as described in this manual. Check the terrain carefully before descending any hill. **Do not** descend hills at high speed or at an angle which would cause the vehicle to lean sharply to one side. When possible, go straight down the hill.
21. Drivers **must** follow proper procedures for traveling across the side of a hill, as described in this manual. Avoid hills with excessively slippery or loose surfaces. While on a hill, **do not** attempt to turn this vehicle around. When possible, avoid traveling across the side of a steep hill.
22. Driver **must** use proper procedures when stalling or rolling backwards while ascending a hill. To avoid stalling, maintain a steady speed when ascending.
23. Drivers **must** always check for obstacles before operating on new terrain. **Do not** attempt to drive over large obstacles, such as large rocks or fallen trees.
24. Drivers **must** take precautions to avoid skidding or sliding. On slippery surfaces, such as ice, operate the vehicle slowly and cautiously in order to reduce the chance of skidding or sliding.
25. **Do not** drive this vehicle through water deeper than 8 inches. **Do not** attempt to enter water that exceeds the recommended maximum depth. When driving through water, drive slowly and carefully avoiding sudden movements. Maintain a slow and steady forward motion, and **do not** make sudden turns or stops, or make sudden changes to the vehicle speed.
26. Wet brakes may have reduced stopping ability. Brakes **must** be tested after leaving water. If necessary, apply the brakes lightly several times to allow friction to dry out the brake pads.

27. Drivers **must** ensure that there are no obstacles or people behind the vehicle when driving in reverse. When it is safe to drive in reverse, drive slowly. Avoid turning at sharp angles while driving in reverse.
28. This vehicle **must** be equipped with the proper size and type of tires specified in this manual. Always maintain proper tire pressure, as described in this manual.
29. Vehicle accessories **must** be installed properly. **Do not** attempt to use this vehicle with accessories that are installed or used improperly.
30. **Do not** exceed the stated load capacity of the vehicle. Cargo should be distributed evenly from side to side and secured so that it cannot move during the operation of the vehicle. Reduce speed, allow greater distance for braking, and follow the instructions in this manual for carrying cargo or pulling a trailer.

## 2. Vehicle Warning Decals

Below are the warning decals that have been affixed to this vehicle.

1.



2.



3.



4.



5.



6.



7.



8.



9.



10.



11.



12.



13.

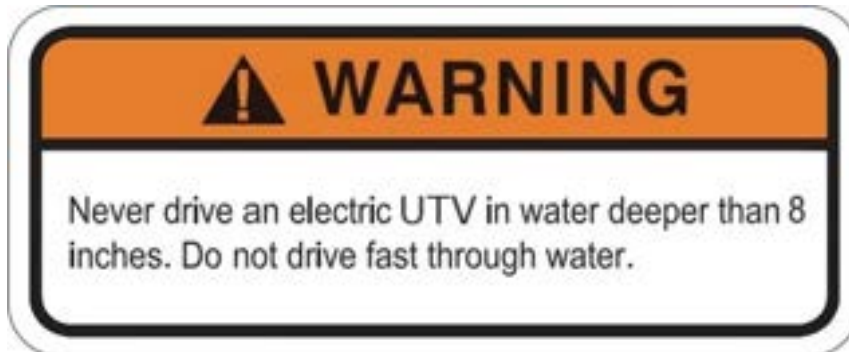

14.



15.



### 3. Vehicle Safety Alerts

The following vehicle safety alerts address many common issues that may arise during the operation and maintenance of this vehicle. Ensure that all drivers read and understand these alerts before attempting to operate the vehicle. Failure to do so could potentially result in serious injury or death.

1.

	<b>WARNING</b>	Do not drive this vehicle with more than one passenger, as this could lead to loss of control of the vehicle and could result in serious injury or death.
---	----------------	---

This vehicle is only intended for use with one driver and one passenger.

2.

	<b>WARNING</b>	Failure to wear a seatbelt or failure to wear the seat belt properly could result in serious injury or death.
---	----------------	---

Always ensure that the driver and all passengers wear their seatbelt properly when riding in the vehicle. A properly fitting seatbelt is close fitting across the hips and chest and is latched securely. In the event of an accident, failure to wear a seatbelt or failure to wear the seat belt properly increases the risk of serious injury and death.

3.

	<b>WARNING</b>	Operating or riding in this vehicle without wearing a DOT approved helmet, eye protection, and protective clothing could result in serious injury or death.
---	----------------	---

Drivers and all passengers must always wear a properly fitting Department of Transportation (DOT) approved off-road motorcycle helmet, eye protection, gloves, boots, long-sleeved shirt or jacket, and long pants.

4.

**WARNING**

Operating this vehicle requires strong judgement and physical skills. Persons with cognitive or physical disabilities who operate the vehicle are at increased risk of overturning or losing control of the vehicle, which could result in serious injury or death.

Always ensure that individuals operating this vehicle are able to do so safely. If there is any doubt that a person can operate this vehicle safely, **do not allow them to operate this vehicle.**

5.

**WARNING**

Driving this vehicle on paved roads, such as parking lots, sidewalks, driveways, and streets, could lead to loss of control of the vehicle, and could result in serious injury or death.

The tires on this vehicle are designed for off-road use only. Driving this vehicle on a paved road will dramatically change the handling of the vehicle.

6.

**WARNING**

Do not drive this vehicle on public roads or highways. If it is necessary to cross a paved road, drive slowly and do not brake suddenly.

This vehicle is only intended for off-road use.

7.

**WARNING**

Do not attempt wheelies, jumps or any other stunts with this vehicle. Doing so could lead to loss of control of the vehicle and result in serious injury or death.

Always drive this vehicle in a responsible manner.

8.



**WARNING**

Operating this vehicle at excessive speeds increases the chance of losing control of the vehicle and could result in an accident.

Always travel at a speed that is suitable for your level of experience, the terrain, visibility, and operating conditions.

9.



**WARNING**

Operating the vehicle without being familiar with all controls could lead to a loss of control, resulting in accident or injury.

Read the owner's manual carefully. If there is any aspect of the vehicle or vehicle operation that you do not understand, please contact an authorized dealer or Kandi customer service.

10.



**WARNING**

Consuming drugs or alcohol before or while operating this vehicle could result in serious injury or death.

Never consume drugs or alcohol before or while operating this vehicle. Drugs and alcohol can seriously affect the driver's judgement, slow their reaction time, affect their balance and perception, and could result in an accident.

11.



**WARNING**

Failure to release the parking brake before driving could cause the wheels to lock and cause loss of control of the vehicle, which could result in serious Injury or death.

Always ensure that the parking brake is released before driving the vehicle.

12.

**WARNING**

Removing your hands from the steering wheel or feet from the floorboard during operation of the vehicle can result in accident or injury.

Removing even one hand from the steering wheel or one foot from the floorboard can reduce the driver's ability to control the vehicle, and doing so could cause the driver to lose their balance and fall out of the vehicle. Always keep both hands on the steering wheel and both feet on the floorboard of your vehicle during operation.

13.

**WARNING**

Skidding or sliding on slippery surfaces may cause the driver to lose control of the vehicle. While sliding or skidding, the vehicle may suddenly regain traction, which can cause the vehicle to overturn.

On slippery surfaces, such as ice, go slowly and be very cautious in order to reduce the chance of skidding or sliding out of control. While skidding or sliding, the vehicle may suddenly regain traction, which can cause the vehicle to overturn and could result in serious injury or death.

14.

**WARNING**

Improperly operating the vehicle over obstacles could cause a loss of control, collision, or cause the vehicle to overturn.

Check for any obstacles before operating the vehicle in a new area. Do not attempt to drive this vehicle over large obstacles, such as large rocks or fallen trees. If you are unable to avoid an obstacle, always follow the proper procedures as described in this owner's manual.

15.

**WARNING**

Driving a vehicle with a malfunctioning accelerator pedal could result in accident or injury.

A malfunctioning accelerator pedal may become difficult to operate, affecting the driver's ability to speed up or slow down when necessary, and could lead to an accident or injury. Drivers must always check the operation of the accelerator pedal before starting the engine. If the accelerator pedal is not working smoothly, correct the issue before operating the vehicle. If you are unable to locate or solve the problem on your own, contact an authorized dealer or service center for assistance.

16.

**WARNING**

Attempting to drive the vehicle with malfunctioning brakes could result in accident or injury.

Always check the brakes before operating the vehicle. Do not attempt to operate a vehicle that has brakes that are functioning improperly. If the brake function cannot be corrected using the adjustment procedures provided in this owner's manual, the vehicle must be inspected and serviced by an authorized dealer or service center.

17.

**WARNING**

Attempting to stop the vehicle from rolling over could result in serious injury.

As with any off-road capable vehicle, this vehicle is at risk of rollover in certain conditions. Uneven terrain or slopes that pitch the vehicle sideways, turning too fast or too sharp, or a combination of these conditions, can increase the risk of vehicle rollover. If the vehicle is tipping, do not attempt to put your arms or legs outside the vehicle or try to use your arms or legs to stop the vehicle from tipping over. Doing so could lead to crushed hands, feet, arms, or legs, or other serious injury. All occupants must keep their arms and legs inside the vehicle until it stops moving.

18.

**WARNING**

After a rollover or accident, this vehicle must be inspected and serviced by an authorized dealership or service center.

Please contact Kandi for assistance finding an authorized dealer or service center.

19.

**WARNING**

Skidding or sliding on slippery surfaces may cause the driver to lose control of the vehicle. While sliding or skidding, the vehicle may suddenly regain traction, which can cause the vehicle to overturn.

On slippery surfaces, such as ice, go slowly and be very cautious in order to reduce the chance of skidding or sliding out of control. While skidding or sliding, the vehicle may suddenly regain traction, which can cause the vehicle to overturn and could result in serious injury or death.

20.

**WARNING**

Operating this vehicle through deep or fast-flowing water could result in accident or injury.

Never operate the vehicle in water that exceeds the recommended maximum depth listed in this manual, or through fast-flowing water. Doing so may cause the tires to float, which can cause a loss of traction and loss of control that could result in an accident. If you cannot avoid a water obstacle, go slowly, balance your weight carefully, avoid sudden movements, and maintain a slow and steady forward motion. Do not make sudden turns or stops, and do not accelerate suddenly.

**NOTE:** Wet brakes have reduced stopping ability. Always test your brakes after leaving the water and, if necessary, apply the brakes lightly several times to allow friction to dry out the brake pads.

21.

**WARNING**

Use of improper tires or tires that have improper or uneven tire pressure could cause a loss of control and increase the risk of an accident.

Always use the size and type of tires that are specified in this owner's manual. Before operating the vehicle, ensure that the tires are inflated to the proper pressure. When seating the tire beads, always use the proper tire pressure that is specified on the sidewall of the tire. Exceeding the specified tire pressure could cause the tire to burst. Inflate the tires slowly and carefully, as rapid inflation could cause the tire to burst.

22.

**WARNING**

Improperly installed accessories and improper modifications can change the way this vehicle handles, which could lead to an accident.

Do not attempt to operate this vehicle if it has improperly installed accessories or improper modifications. All parts and accessories on this vehicle must be genuine parts or equivalent components specifically intended for use on this vehicle and must be installed and used according to manufacturer instructions. If you have any questions, please contact an authorized dealer or service center.

23.

**WARNING**

Improper charging could result in serious injury.

Charge the battery using the supplied charging cable. Disconnect the power supply when the light on the charging indicator turns green. If the charging indicator, charging socket, or charging cable are faulty and will not charge the vehicle battery, please contact an authorized dealer or service center.

24.

**WARNING**

Do not plug in or unplug electrical components while the vehicle is turned on. Failure to follow this instruction could result in serious injury or death.

Installing or removing electrical components while the vehicle is turned on can cause poor contact or an arc fault, which may cause in signal interference or damage to the electrical components or cause the driver to lose control of the vehicle, which could result in serious injury or death.

25.

**WARNING**

Washing the vehicle with a large amount of water or using a wet cloth to clean electrical components or batteries could result in serious injury or death.

Excessive water droplets on electrical components could cause short circuits, burn electrical circuits or components, cause fire or leakages, or cause other issues that could result in serious injury or death.

26.

**WARNING**

Failure to properly maintain the vehicle or inspect the vehicle before operation increases the possibility of vehicle damage and accidents.

Always follow the procedures and schedules for inspection and maintenance that are described in this owner's manual. Always inspect the vehicle before operation to ensure that it is safe operating condition. Failure to properly maintain the vehicle or inspect the vehicle before operation increases the possibility of accidents.

### 4. Vehicle Identification Number (VIN)

The VIN is found in two locations. The VIN can be found on the factory nameplate, which is affixed to the vehicle frame on the driver side underneath the cargo bed near the rear shock absorber mounting bracket.



Factory Nameplate Example

The VIN can also be found etched on the frame on the front driver side of the vehicle near the motor in the location circled in the image below.



For your future reference, please record this number in the space provided below:

--	--	--	--	--	--	--	--	--	--	--	--	--	--	--	--	--	--	--	--

## 5. Vehicle Display

### 5.1 Instrument Panel Diagram

This vehicle has a 10-inch touchscreen display that turns on automatically when the vehicle is started and functions as the instrument panel. The touchscreen shows the speedometer, the current gear, a clock, the vehicle's state of charge, the distance of the current trip, the odometer, and the warning lights.

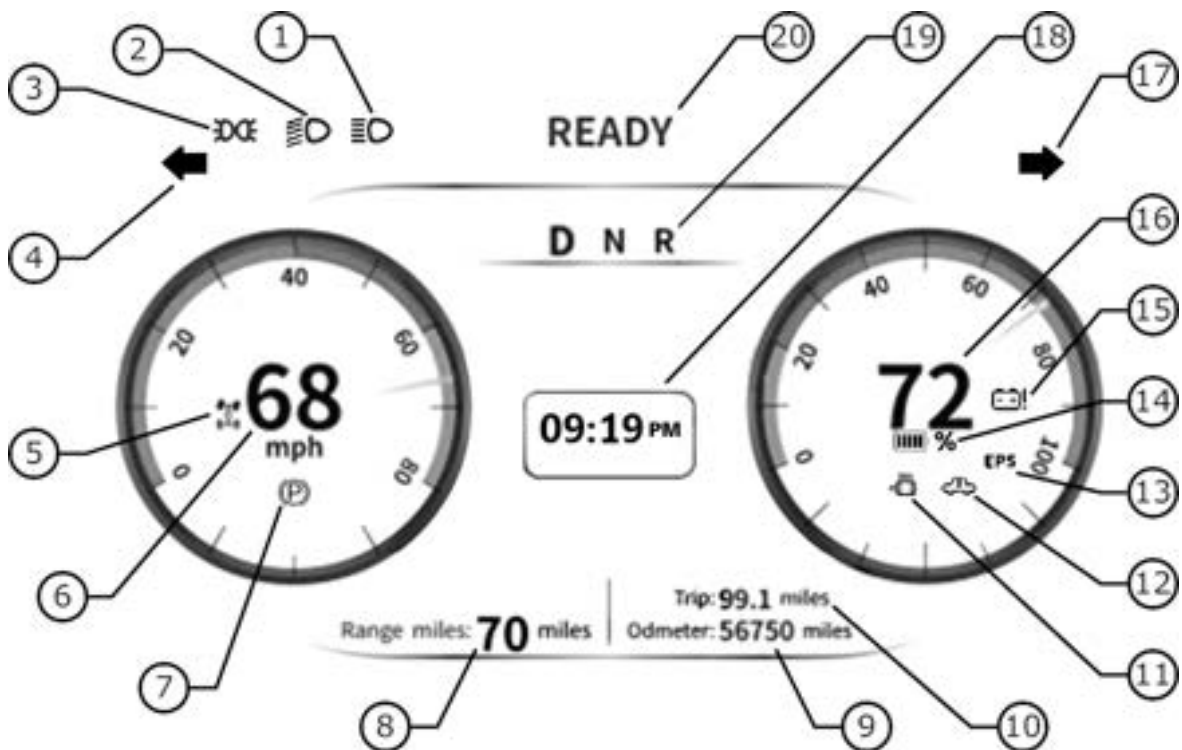

- |                            |  |   |
|----------------------------|--|---|
| 1. High beam indicator     | 9. Odometer                            | 15. Battery undervoltage indicator              |
| 2. Low beam indicator      | 10. Trip odometer                      | 16. Battery state of charge numerical indicator |
| 3. Headlight indicator     | 11. Overheated motor warning indicator | 17. Right turn indicator                        |
| 4. Left turn indicator     | 12. System fault indicator             | 18. Clock                                       |
| 5. 4-Wheel drive indicator | 13. EPS fault indicator                | 19. Gear position indicator                     |
| 6. Speedometer             | 14. Battery state of charge indicator  | 20. Vehicle ready indicator                     |
| 7. Parking brake indicator |  |   |
| 8. Range miles             |  |   |

## 5.2 Instrument Panel Indicators

### 1. High beam indicator

This is displayed when the high beam headlights are illuminated.

### 2. Low beam indicator

This is displayed when low beam headlights are illuminated.

### 3. Headlight indicator

This is displayed when high beam or low beam headlights are illuminated.

### 4. Left turn indicator

This flashes while the left turn signal is turned on.

### 5. 4-Wheel drive indicator

This indicates that 4-wheel drive is engaged.

### 6. Speedometer

This displays a numerical value that reflects the current speed of the vehicle. The digital gauge pointer indicates the current speed of the vehicle.

### 7. Parking brake indicator

This is displayed when the parking brake is engaged.

### 8. Range miles

This displays an estimate of the remaining distance that the vehicle can travel before it must be charged.

### 9. Odometer

This displays the total number of miles that the vehicle has traveled.

### 10. Trip odometer

This displays the total number of miles that the vehicle has traveled during the current trip and will reset when the vehicle is powered off.

**11. Overheated motor warning indicator**

This is displayed when the motor has overheated.

**12. System fault indicator**

This is displayed when there is a system fault.

**13. Electric power steering (EPS) fault indicator**

This is displayed when there is an EPS fault.

**14. Battery state of charge (SOC) indicator**

This uses color-coded graphics to indicate the current state of charge.



When the battery symbol is displayed in red, this indicates that the SOC is below 20%.



When the battery symbol is displayed in yellow, this indicates that the SOC is below 40%.



When the battery symbol is displayed in green, this indicates that the SOC is greater than 40%.

When the vehicle is charging, the battery symbol will cycle through the red, yellow, and green symbols displayed above.

**15. Battery undervoltage indicator**

This is displayed when the battery voltage is insufficient.

**16. Battery state of charge (SOC) numerical indicator**

This displays a numerical value that reflects the current SOC of the vehicle. The digital gauge pointer simultaneously indicates the current SOC of the vehicle.

**17. Right turn indicator**

This flashes while the right turn signal is turned on.

**18. Clock**

This displays the current time. (See section [6.5 Setting the Clock](#) for more info)

**19. Gear position indicator**

The currently engaged gear will be highlighted. If none of the gears are highlighted and magnified, this indicates that a gear position signal failure.

**20. Vehicle ready indicator**

READY is displayed when the vehicle is in a state where it is ready for use.

**5.3 Battery and Motor Status**

Swiping to the left will reveal more information about the vehicle, including the battery status, the motor status, and any fault codes. These values are displayed in real time.

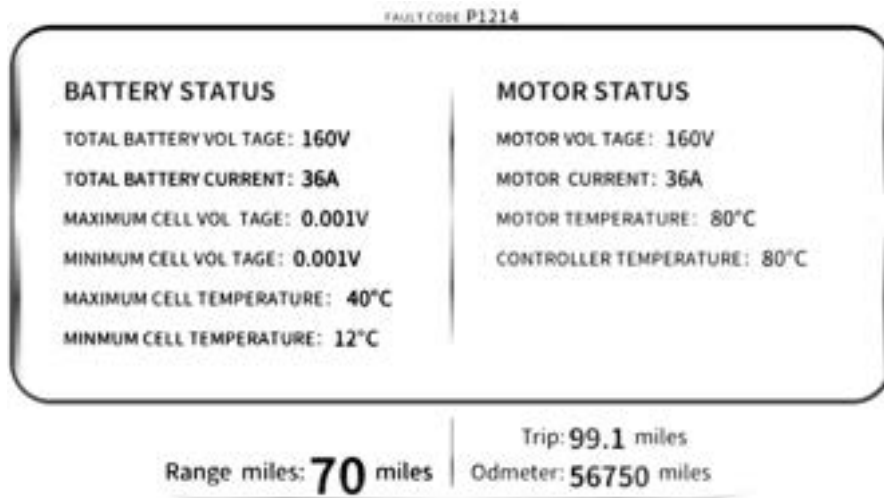

## 5.4 Charging Screen

When the vehicle is plugged into the charger, the touchscreen display will automatically change to the charging screen and show the state of charge (SOC) and an estimate of the distance that the vehicle can travel before it must be charged again.

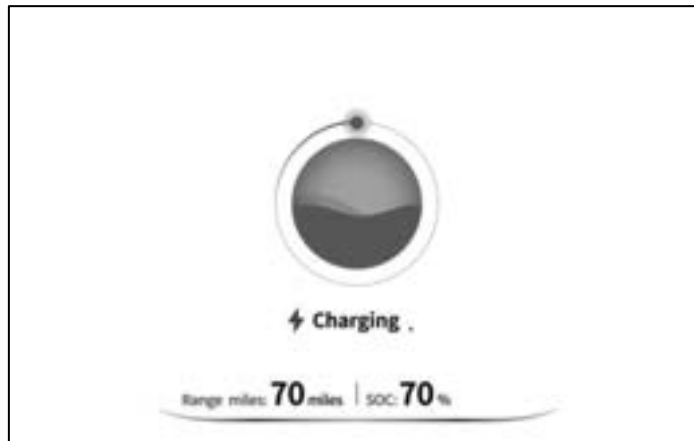

**NOTE:** Due to temperature or other factors, the displayed SOC estimate may stall at 99%. Should this happen, the vehicle should be considered fully charged at 99% SOC.

## 5.5 Setting the Clock

The touchscreen display on this vehicle is an Android tablet. The Android system settings must be accessed to change the time.

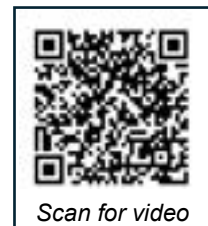

1. Swipe up from the bottom of the screen for the navigation controls, then press the circle to go to the home screen.



2. Select "settings" from the home screen



- 3. Inside settings, scroll down and select “system”

**Note:** Please ignore the battery reading on the tablet, as the tablet is hardwired

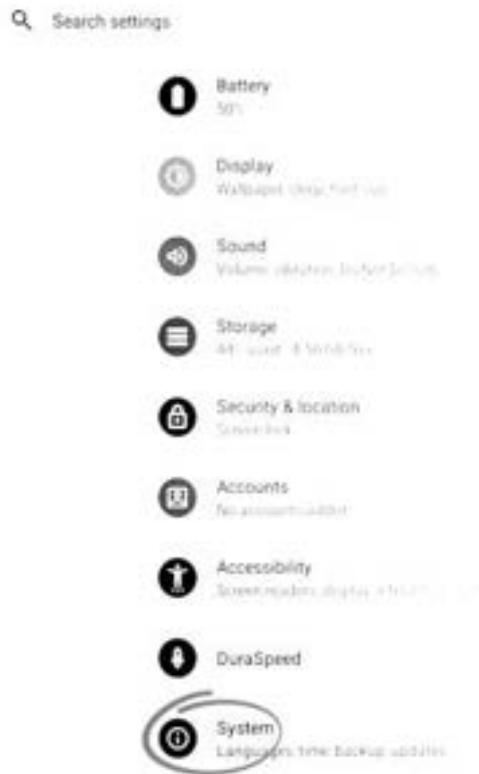

- 4. Inside the system settings, select “date & time”



5. Inside the date & time settings, select “automatic date & time”



6. Inside the automatic date & time menu, select “off”

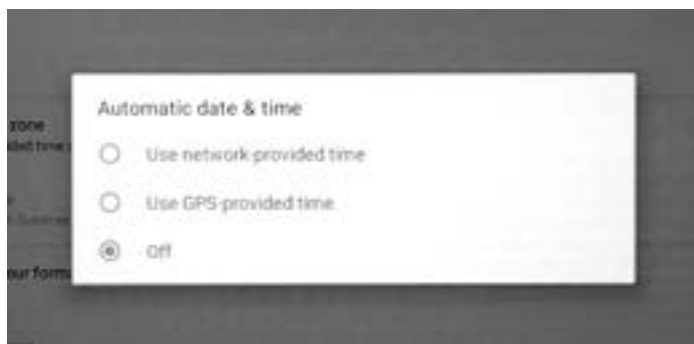

7. Once the automatic date & time setting is turned off, select "set time" to adjust the vehicle's clock to your local time

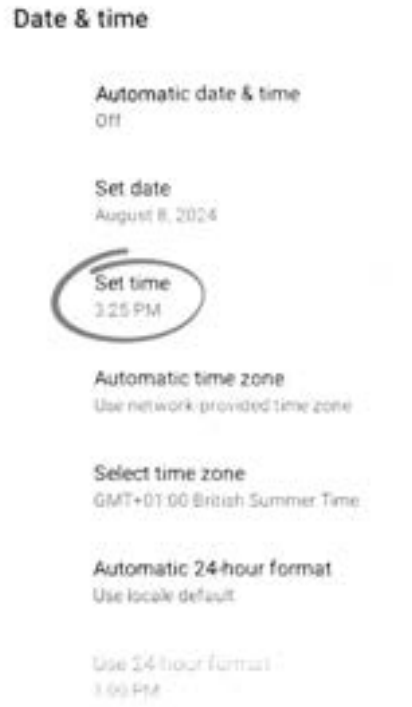

8. To return to the vehicle controls, either navigate back to the home screen and select the "Kandi" app or turn the vehicle off and back on.

## 6. Vehicle Controls & Parts

### 6.1 One-Click Start

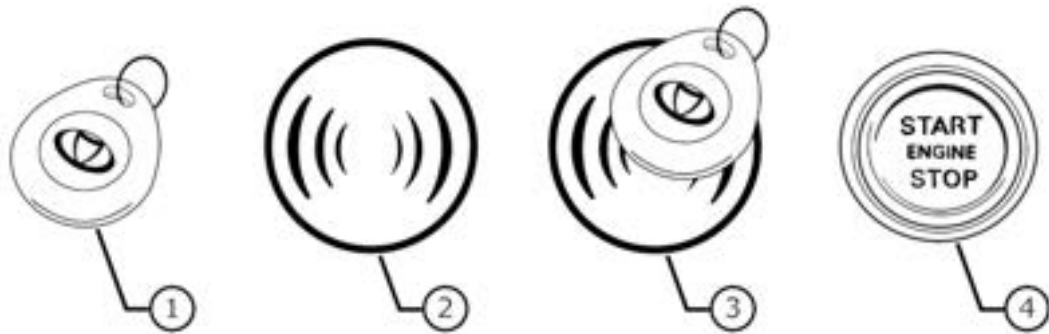

When the key fob (1) is placed near the NFC sensor (3), the vehicle will beep twice, and the start button (4) will flash red. When the start button is pressed, the vehicle and the instrument panel will turn on, and the start button will turn green. To turn off the vehicle, make sure that it has come to a complete stop, then press the start button (4).

**NOTE:** If the start button is not pressed within 10 seconds after the key fob is placed near the NFC sensor, the vehicle will beep, and the start button light will turn off.

### 6.2 Control Switch Diagram

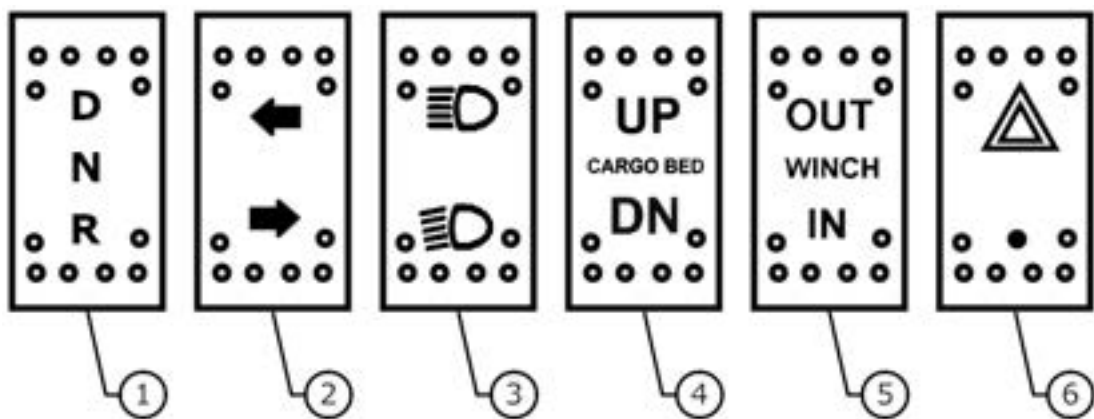

1. Gear switch

3. Headlight switch

5. Winch switch

2. Turn signal switch

4. Cargo bed switch

6. Hazard warning light switch

## 6.3 Control Switch Details

### 1. Gear switch

#### **D (Drive):**

Press the gear switch up to put the vehicle in drive. When the vehicle is in drive and the accelerator pedal is depressed, the vehicle will move forward.

#### **N (Neutral):**

When the gear switch is in the middle position, the vehicle is in neutral. When the vehicle is put into neutral and the accelerator pedal is depressed, the vehicle will not move. When parking, the vehicle should be placed in neutral.

#### **R (Reverse):**

Press the gear switch down to put the vehicle in reverse, and the backup camera image will replace the instrument panel display, the vehicle motion alarm will sound, and the reverse lights on the rear of the vehicle will illuminate. When the accelerator pedal is depressed, the vehicle will move in reverse.

### 2. Turn signal switch

#### **Left turn signal:**

Press the turn signal switch up to activate the left turn signal.

#### **Right turn signal:**

Press the turn signal switch down to activate the right turn signal.

### 3. Headlight switch

#### **High beams:**

Press the headlight switch up to activate the high beam headlights.

#### **Low beams:**

Press the headlight switch down to activate the low beam headlights.

#### 4. Cargo bed switch

**UP:** Press the cargo bed switch up to raise the cargo bed.

**DN (Down):** Press the cargo switch down to lower the cargo bed.

#### 5. Winch switch

When the vehicle is turned on, pressing the winch switch down will retract the winch cable, while pressing the winch switch up will extend the winch cable. When the winch is not in use, the switch should be left in the neutral middle position.

**NOTE:** Before attempting to extend the winch cable, ensure that the winch clutch knob is turned to the "FREE SPOOL" position. Before attempting to retract the cable, ensure that the winch clutch knob is turned to the "ENGAGE" position. The illustration to the right shows the winch clutch knob in the "ENGAGE" position.



#### 6. Hazard warning light switch

When the hazard warning light switch is pressed down, the left and right turn signals will both be activated. When the switch is pressed up, the turn signals will turn off.

#### 6.4 USB Charging Ports

This vehicle comes equipped with USB-C (1) and USB-A (2) charging ports. To turn on the charging ports, press the power button (3). The charging ports are illuminated when turned on. Please note that the charging ports must be turned on to supply power.

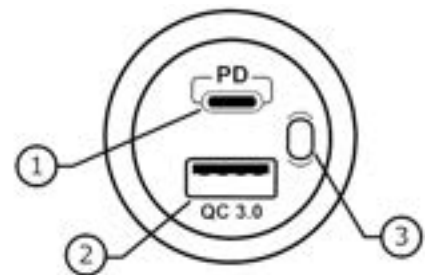

#### 6.5 Horn Switch

To activate the horn, firmly press the center of the steering wheel (1).

### 6.6 Fuse Box

This vehicle is equipped with two fuse boxes.

One fuse box is installed on the 12V starting battery and contains fuses for the electric winch (100A), power light (40A), EPS (40A) and the DC-to-DC converter (100A).

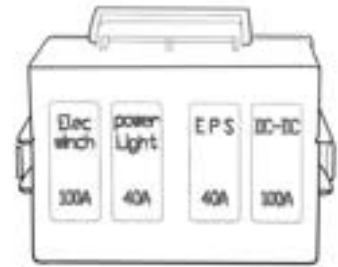

12V Starting Battery Fuse

The second fuse box is under the hood on the left side.

Please note that this fuse box has 3 horizontal slots where spare fuses may be stored.

**NOTE:** When replacing a fuse, always use a fuse of the same kind and rating.



Cargo Box Motor	Battery, DMCM	Brake, EPS	Winch		Horn, Lights	Display, T-Box	T-BOX, EPS, OBD	Display	Battery
20A	10A	10A	15A		15A	10A	5A	5A	5A

Fuse Diagram for Passenger Seat Fuse Box



### 6.7 Charging Socket

The charging socket conforms to SAE-J 1772 and is located on the left side of the driver's seat. Before charging the vehicle, first pull the latch of the charging socket cover to expose the charging socket.

## 6.8 Pedals

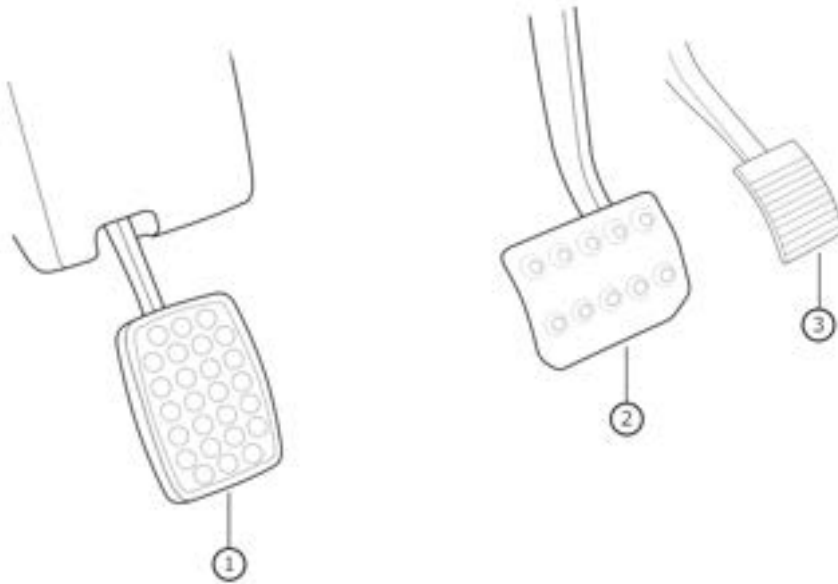

### 1. Parking Brake Pedal

To engage the parking brake, fully depress the parking brake pedal (1). While the parking brake is engaged, the parking brake pedal will remain at the bottom of its range of motion. To disengage the parking brake, fully depress the parking brake pedal, then quickly allow the pedal to return to the disengaged position.

**NOTE:** Always check to make sure the parking brake is disengaged before driving.

### 2. Brake Pedal

Depressing the brake pedal (2) while the vehicle is in motion will cause the vehicle to decelerate. Fully depressing the brake pedal will bring the vehicle to a stop.

**NOTE:** Always check that the brakes are fully operational before driving the vehicle.

### 3. Accelerator Pedal

Depressing the accelerator pedal (3) will increase the speed of the drive motor and will cause the vehicle to move.

## 6.9 Seat Belts

This vehicle is equipped with three-point seat belts for the driver and passenger.



### **WARNING**

The driver and passenger must always wear their seat belts. In the event of an accident, failure to wear a seat belt increases the risk of serious injury or death.

### **Proper Use of the Seat Belt**

1. While sitting in the seat, pull the seat belt across your chest toward the hip on the opposite side. Do not pass the seat belt through your armpit or allow the seat belt to twist.
2. Push the latch plate into the buckle until you hear an audible click, then pull up on the latch plate to check that it is secure.
3. The lap portion of the seat belt should sit low on your hips. Pull up on the portion of the seat belt passing over your chest to ensure that it fits snugly against your hips.
4. To release the buckle, firmly press the red release button.
5. When there is no passenger in the vehicle, ensure that the passenger seat belt is buckled and secure.

## 7. Safety Gear

Always wear clothing that is suitable for the way you are using the vehicle. Wearing special protective clothing will help you to feel more comfortable and reduce the chance of injury.

### 7.1 Helmets

A helmet is the most important piece of protective equipment that you can wear. Helmets are the best protection against serious head injuries. When selecting a helmet, always select a DOT approved off-road motorcycle helmet that fits properly.

### 7.2 Eye Protection

Protective goggles or a helmet face shield are the best options for protecting your eyes.

### 7.3 Gloves

Off-road-style gloves provide important protection for your hands.

### 7.4 Boots

Tall, hard-soled boots with tough heels that cover the calf, such as motocross boots, provide important protection for your lower extremities.

### 7.5 Clothing

Long sleeves and pants should always be worn when operating or riding in this vehicle. Protective motocross clothing that includes padding for your knees and shoulders offers the best protection.



#### **WARNING**

Operating this vehicle without a DOT approved motorcycle helmet and eye protection could result in serious injury or death.

## 8. Breaking-in a New Vehicle

To ensure optimal future performance of the vehicle, extend its service life, and improve its reliability and economy, please follow the following instructions:

1. During the first 300 miles of the service life of the vehicle, always accelerate gradually and do not suddenly depress the accelerator pedal fully or attempt a full-throttle take-off.
2. During the first 200 miles of the service life of the vehicle, unless there is an emergency, do not fully depress the brake pedal to come to a sudden stop. Always gradually press the brake pedal in order to decelerate gradually.
3. During the first 200 miles of the service life of the vehicle, avoid driving the vehicle at a fixed speed for a long period of time. Make sure to vary the speed of the vehicle in order to fully break-in the moving parts on the vehicle.
4. Avoid discharging the LiFePO<sub>4</sub> battery to below 20% state of charge (SOC). Ensure that the battery is charged regularly to maintain a SOC above 20%.

### NOTE:

- Before driving, always ensure that the parking brake pedal is released. Failure to release the parking brake could damage the brake pads.
- Always fill and replace the gear oil in the front and rear gearboxes according to the requirements of this manual.
- When replacing a fuse, always use a fuse of the same kind and rating.
- Suddenly depressing the accelerator pedal fully or attempting a full-throttle take-off will shorten the service life of the motor and controller.

## 9. Driving the Vehicle



### WARNING

Operating this vehicle at excessive speeds increases the chance of losing control of the vehicle and could result in an accident. Always travel at a speed that is suitable for your level of experience, the terrain, visibility, and operating conditions.

### 9.1 Startup

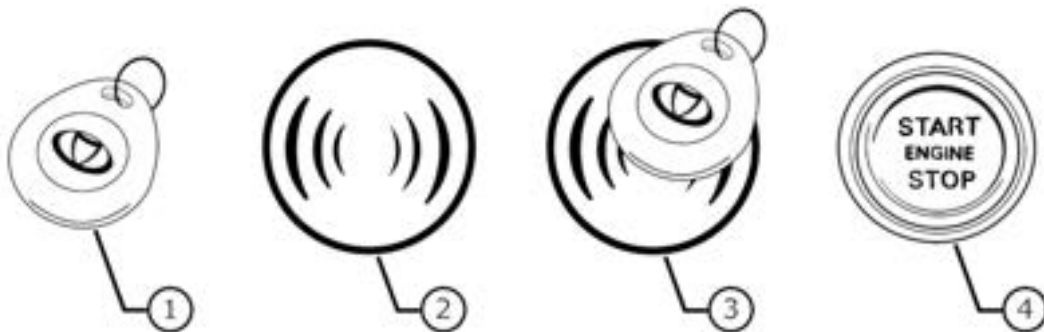

1. Ensure that the gear switch is in neutral ("N"), and the parking brake is engaged.
2. Sit in the driver's seat and release the parking brake. Then, while holding the key fob (1), locate the NFC sensor (2) and place the key fob near the NFC sensor (3). The sensor should then beep twice.
3. Hold down the brake pedal and press the one button start switch (4) to turn on the vehicle.

**NOTE:** When turning off the vehicle, the brake pedal must be held down while the start switch (4) is pressed.

4. Wait for the "READY" indicator light to appear on the instrument panel screen.

**NOTE:** If "READY" does not appear on the instrument panel screen, this indicates an issue that must be addressed before driving the vehicle.

## 9.2 Start Driving

1. After the vehicle turns on, depress the brake pedal, press the gear switch up to select drive ("D"), and release the brake pedal.
2. Slowly depress the accelerator pedal until the vehicle begins to move.
3. Drive slowly and cautiously until you are familiar with the handling characteristics of the vehicle.

## 9.3 Driving Up Hills

1. Before attempting to climb a hill in this vehicle, first stop and assess the situation. Make sure the hill is not too steep to climb, the terrain is not loose, and there are no obstacles.
2. Approach the top of the hill at a stable speed.
3. After the front wheels have reached the top of the hill, release the accelerator pedal and slow down. This will prevent the vehicle from becoming airborne and landing heavily, which could damage the vehicle and injure the vehicle occupants.

**NOTE: Practice driving up small slopes before attempting to drive up a steep slope. The maximum slope that this vehicle can safely climb is a 30% grade.**



### **WARNING**

Crossing steep or loose hillsides could cause the vehicle control or overturn and could result in damage to the vehicle or serious injury or death.



### **WARNING**

Hard braking on a slippery surface could cause the wheels to lock, and cause loss of control of the vehicle, or cause the vehicle to overturn or slide, which could result in serious injury or death.

If you determine that the vehicle cannot reach the top of the hill:

1. While the vehicle is moving, do not attempt to turn around and travel down the hill, as this could cause the vehicle to roll down the hill.
2. Come to a complete stop, then slowly pump the brake pedal to allow the vehicle to travel backwards down the hill at a slow, controlled speed.

Alternatively:

1. Bring the vehicle to a complete stop, then hold down the brake pedal to prevent the vehicle from rolling backwards.
2. If you feel unable to safely park the vehicle on the mountain, hold down the brake pedal and engage the parking brake.
3. Release the brake pedal slowly, ensure that the vehicle is still at a complete stop, then once the vehicle is safely parked, carefully climb out of the vehicle.
4. Check the surrounding environment, and once you are safe, **do not walk behind the vehicle**, quickly leave the hill or incline, and seek help.

#### 9.4 Driving Down Hills

1. Before attempting to drive down a hill, stop and make sure the hill is not too steep, the terrain is not loose or slippery, and there are no obstructions.
2. Always closely control the speed of the vehicle while driving down a hill, and do not drive too quickly. Stepping on the brakes when the vehicle is moving too quickly can easily cause the vehicle to lose control and overturn.



#### **WARNING**

Do not drive this vehicle on hills steeper than the grade for which it is rated. Driving up and down hills can be dangerous and increases the risk of roll-over. Always drive cautiously on hills, as irresponsible driving could result in serious injury or death.

## 9.5 Skidding or Sliding

In some cases, the vehicle may slip or slide even when the brake pedal is not depressed. Regain control by following the driving techniques listed below.

If the front wheels begin to slip or slide:

- Restore traction by releasing the accelerator pedal.
- Do not step on the brake pedal.

If the rear wheels begin to slip or slide:

- Restore traction by releasing both the accelerator and brake pedals until you regain control of the vehicle.

## 9.6 Driving Across Water

Driving across water is dangerous, especially when the vehicle is moving at high speeds. Make sure that any water the vehicle crosses is not deeper than 8 inches.

Before crossing any area that contains water, check the terrain to ensure that it can be crossed safely. Do not attempt to cross unfamiliar terrain or areas with water. Always protect the environment and do not enter protected waters, such as rivers.

If the vehicle is driven in muddy, wet, or sandy environments, the brakes must be checked, cleaned, and replaced frequently. Check the vehicle brakes regularly, and clean or replace the brakes according to the maintenance requirements.

## 9.7 Brake Check

After turning on the vehicle, drive at a slow speed (walking speed) on flat ground, then test the brakes and check the braking ability of the vehicle. Make sure the front and rear brakes are working properly.

If the vehicle is not braking normally, contact an authorized dealer or service center to have the brakes inspected and serviced.

**Never attempt to drive a vehicle that has malfunctioning brakes.**

## 9.8 Driving in Cold Weather



### WARNING

Driving this vehicle with wet or frozen brakes will increase the braking distance of the vehicle, which may result in loss of control of the vehicle, serious injury, or death.

Check the following items before driving:

1. The brake pedal, accelerator pedal and parking pedal must be checked before driving the vehicle in cold weather, as ice and snow may cause them to freeze. Check the connection mechanism of the brake pedal, accelerator pedal, and parking pedal to ensure that they are working properly. If the mechanism is frozen, move the vehicle to a warm area to thaw.
2. Check whether the vehicle tires are frozen to the ground. If they are frozen, thaw the tires by pouring warm water on and around the tires.



### CAUTION

In freezing temperatures, ensure that the wheels are able to move freely before starting or attempting to drive the vehicle.

In the winter, if the front, rear or both sets of brakes fail, move the vehicle to a warm place to allow the brakes to thaw. After the brakes have thawed, check whether the vehicle can now brake normally. If the vehicle is still unable to brake normally, contact an authorized dealer or service center to have the brakes inspected and serviced. **Never attempt to drive a vehicle that has malfunctioning brakes.**

Preventive maintenance is very important in cold weather. When using the vehicle in cold weather, driving through snow, mud, water, or ice may cause the brake pedal and accelerator pedal mechanisms to freeze. When necessary, apply the brakes lightly several times to allow friction to dry out the brake pads. Using a protective cover on the vehicle can prevent snow accumulation.

## 9.9 Loading Guide

The combined weight of the driver, passengers and cargo must not exceed the maximum load capacity of vehicle. Please see the technical specifications on the last page of the owner's manual for more information.

The maximum load capacity of the cargo box is 441 lbs (200 kg). Always ensure that any cargo is well secured, as loose cargo has the potential to cause damage to the vehicle or cause injury to the driver or passenger. Always that the weight of the cargo is evenly distributed and has a low center of gravity. Cargo with a high center of gravity will make the vehicle more likely to tip over.

Always ensure that any cargo and accessories do not interfere with the driver's ability to control the vehicle. Do not load heavy or overweight cargo.

Slow down and drive carefully when transporting cargo in the vehicle. Transporting cargo makes high-speed driving dangerous.

When carrying cargo, always ensure that proper braking distance is maintained. The greater the combined weight of the vehicle, passengers, and cargo the longer the required braking distance will be.

## 9.10 Accessories

Accessories for this vehicle should only be purchased from Kandi America. The quality, safety, and suitability of third-party accessories cannot be guaranteed or supported by Kandi America, and the use of any such accessories is entirely at your own risk. Purchasing of improper parts or accessories could cause abnormal or unpredictable operation of the vehicle and could result in damage to the vehicle or serious injury or death. If you have any questions, please contact an authorized dealer or service center.



### **WARNING**

Do not modify this vehicle. Modifications and accessories may negatively impact the handling of this vehicle and could result in severe injury or death.

## 10. Battery

This vehicle is equipped with three 25V 150Ah lithium iron phosphate (LiFePO<sub>4</sub>) batteries, and one standard 12V sealed lead-acid starting battery. The lithium batteries are located in the compartment underneath the seat cushion in the vehicle cab, and the 12V starting battery is located underneath the front hood of the vehicle.

The longevity of the batteries in this vehicle is directly related to battery use and maintenance.

### 10.1 Examining the Batteries

It is important to regularly check the appearance of the batteries and the battery connections:

1. Check the external surface of both the 12V battery and lithium battery enclosures for deformation or cracks (**do not attempt to open the lithium battery enclosures**). The surface of the battery should be flat, dry, and free from any damage. **If there are any irregularities, do not attempt to turn on or operate the vehicle.** Contact an authorized dealer or service center to have the battery inspected and serviced.
2. Check the connection wires and terminals of the 12V battery for any signs of corrosion. If corrosion is present, clean the terminals and connectors. A corrosion inhibitor can be used to minimize corrosion.
3. Check to make sure that the terminals are secure by grasping the connected cable several inches from any metal parts and gently moving the cable. Do not attempt to grab the fastener or battery terminal with any tools. **If either battery terminal is loose, do not attempt to turn on or operate the vehicle.** Contact an authorized dealer or service center to have the battery inspected and serviced.

## 10.2 Avoiding Short Circuits



### WARNING

A short circuit could lead to an explosion that could result in serious injury or death.

The current of a short circuit can reach thousands of amperes and generate high amounts of heat that can damage the battery, cause battery leakage, or even cause an explosion that could result in serious injury or death.

Short circuits can be avoided by exercising extreme caution when installing or removing batteries, and when using battery installation tools. Exercise caution when handling the battery cables, as an improperly placed cable could cause a short circuit.

The battery terminals should be covered with an insulating cap, and the battery cables should not be allowed to overlap, as this can produce unwanted pressure on the cables and battery terminals.

## 10.3 Charging the Vehicle

The appropriate charging cable has been provided with this vehicle. The charging cable is used to charge the lithium batteries, and the 12V starting battery is charged by the lithium batteries when the vehicle is turned on. Only the original charging cable should be used with this vehicle. If a replacement charging cable is required, use a genuine Kandi charging cable obtained either from an authorized dealer or service center, or directly from Kandi.

The charging voltage for this vehicle is standard residential 120V.

Before attempting to charge the vehicle, check the charging socket and charging cable plug for damage, stains, or water stains. If there are any abnormalities, **do not attempt to charge the vehicle**. Contact an authorized dealer or service center to have the battery inspected and serviced.

When the charging display shows that the battery has reached 100% state of charge (SOC), the battery is fully charged, and the charging cable should be unplugged.

## Charging Procedures

When facing the front of the vehicle, the charging socket is located to the right of the driver's seat.

1. Open the charging socket cover and plug the J1772 Type 1 connector into the charging socket.
2. Connect the plug at the other end of the charging cable to the standard 120V power supply.
3. When the charging cable is working properly, the charging indicator will appear on the instrument panel when the vehicle is connected to the power supply.
4. Once the vehicle is charged, unplug the end of the charging cable that is connected to the power supply.
5. Then, unplug the J1772 Type 1 connector, and close the charging socket cover.

## Charging Cable Safety Information

1. The charging cable requires a standard 120V power supply. The electrical outlet used for charging the vehicle must be installed by a professional electrician. If the outlet is installed outdoors, always ensure that the charging cable and J1772 Type 1 connector are free from any moisture.
2. Please use a dedicated electrical line for the outlet used to charge the vehicle, similar to the dedicated line used for household air conditioning. It is recommended to use a copper core wire with a wire diameter of 4mm<sup>2</sup> or greater.



### **WARNING**

Moisture on the charging cable or J1772 Type 1 connector increases the risk of electrical shock that could result in serious injury or death.

3. The electrical outlet must be a reliably grounded standard US Type B outlet with rated current  $\geq 16\text{A}$ . For safety purposes, the dedicated electrical line for the electrical outlet used for charging the vehicle must be installed with a corresponding dedicated circuit breaker. When charging the vehicle, please do not use other high-power electrical equipment on the same line.
4. The charging time for a range of 40 miles on a 120V power supply is about 8 hours. The amount of charging time required will vary based on the remaining power, vehicle service time, ambient temperature, and other factors.
5. The vehicle should be charged in a well-ventilated location with an accessible fire extinguisher. Never charge the vehicle in a location where smoking takes place, or in a location where batteries or other flammable materials are stored.
6. If there is looseness between the J1772 Type 1 connector and the charging socket, oxidation of the contact surface and other problems will cause the J1772 Type 1 connector to overheat. If the J1772 Type 1 connector overheats for too long, this can cause a short circuit or result in issues with poor contact. **Do not attempt to charge the vehicle with a damaged or malfunctioning charging cable. To prevent issues with poor contact and the possibility of a short circuit, the charging cable must be replaced.**
7. Children must never be allowed to play on or around a charging vehicle.
8. Never place the vehicle battery in series or parallel with other models or types of batteries. If there is any issue with the battery, contact an authorized Kandi dealership or service center immediately. **Do not attempt to open the battery enclosure or otherwise disassemble the LiFePO<sub>4</sub> lithium battery.**
9. **If there is any smoke, smell or spark during charging, immediately disconnect the power supply and contact an authorized Kandi dealership or service center.**

### 10.4 12V Starting Battery

This vehicle has a 12V 45Ah sealed lead-acid starting battery that is located underneath the front hood of the vehicle. The 12V battery is charged by the lithium battery while the vehicle is powered on, regardless of whether the vehicle is moving or stationary. Please note that the lithium battery cannot charge the 12V starting battery while the vehicle is powered off.

When storing the vehicle for a longer than a few days, the 12V starting battery must either be checked weekly and topped off or connected to battery maintainer that is appropriate for the battery type.



#### **WARNING**

Exercise extreme caution when installing or removing the battery, and when using battery installation tools. For more information, please see section **10.2 Avoiding Short Circuits.**

### Maintaining the 12V Starting Battery

1. Check that the starting battery is properly secured to the vehicle and ensure that the surface of the battery is not damaged or deformed.
2. Check that the battery cables are securely connected and free of corrosion.
3. If the 12V starting battery is equipped with an electric eye, use the electric eye to check the condition of the battery. Green means it is working properly, black means there is power loss, and white means the battery is damaged and needs to be replaced.

### Charging the 12V Starting Battery

1. If the vehicle is not used for a long time, the charging system has a fault, the load voltage of the starting battery is lower than 10V or the no-load voltage is lower than 12.4V, the 12V starting battery must be charged.

2. Connect the red wire of the charging device to the positive (+) battery terminal, and the black wire to the negative ( - ) battery terminal.
3. Ensure that the area where the battery is being charged is well-ventilated and does not contain any flammable items or open flames.
4. If the 12V starting battery is equipped with an electric eye, the electric eye will turn green when the starting battery is sufficiently charged.

**WARNING**

Lead-acid batteries emit hydrogen and oxygen gas while charging. Charge the vehicle in a well-ventilated location where there are no open flames.

**WARNING**

When using a charger for the 12V starting battery, avoid sparks by turning off the charger before connecting it to or disconnecting it from the battery.

### 10.5 Lithium Iron Phosphate (LiFePO<sub>4</sub>) Batteries

This vehicle has three 25V 150 Ah lithium iron phosphate (LiFePO<sub>4</sub>) batteries that are connected in series. These batteries are located in the compartment underneath the seat cushion in the vehicle cab.

It is not recommended for the vehicle's lithium batteries to be stored for an extended period of time without charging. When storing the vehicle, it is important to be mindful of the state of charge (SOC) on the lithium battery and prevent the SOC from dropping below 30%. Before storing the vehicle, ensure that the battery is fully charged.

Storing the vehicle with a battery that is fully depleted will cause **irreversible damage** to the battery. The longer the battery is stored in a fully discharged state, the more serious the damage to the battery is. The lithium battery does not need to be connected to a battery maintainer.

The steel enclosure of the lithium batteries should be kept clean, and the vehicle should be parked in a location that is cool, dry, and well-ventilated. The lithium

batteries should not be exposed to the sun. Sun exposure will increase the temperature of the battery and reduce the battery life.

To prolong the life of the battery, avoid fully depressing the accelerator pedal immediately after turning on the vehicle. Doing so can cause the motor current to rapidly increase and cause the battery to discharge too quickly, which can cause a drop in voltage that will result in reduction in battery life.

It is normal for the battery capacity to decrease as the temperature decreases. At temperatures of  $-10^{\circ}\text{C}$  ( $14^{\circ}\text{F}$ ), the battery capacity will typically be 80%.

**Do not attempt to charge lithium (LiFePO<sub>4</sub>) batteries at temperatures below  $0^{\circ}\text{C}$ .** While the lithium battery can be used in below-freezing temperatures, the internal battery temperature must remain above  $0^{\circ}\text{C}$  ( $32^{\circ}\text{F}$ ) while the battery is being charged.

**CAUTION**

Charging a LiFePO<sub>4</sub> lithium battery at temperatures below  $0^{\circ}\text{C}$  ( $32^{\circ}\text{F}$ ) will irreparably damage the battery.

## 11. Maintenance

Maintenance for this vehicle can be performed by an authorized dealer or service center and should be performed in accordance with the maintenance procedures and maintenance schedule listed in this manual. Proper maintenance is extremely important for ensuring the safety of the vehicle occupants and extending the service life of the vehicle.

When this vehicle is used in harsh conditions, such as wet, muddy, dusty, or sandy environments, maintenance must be performed more frequently.



### WARNING

Failure to properly maintain the vehicle or inspect the vehicle before operation increases the possibility of vehicle damage and accidents.

It is particularly important to perform regular maintenance on the front and rear axles of the vehicle, and their related components. Failure to do so may damage the vehicle. Always maintain these components in accordance with the maintenance schedule listed in this manual and perform service more frequently when the vehicle is driven in harsh conditions.



### WARNING

Always use genuine Kandi parts when servicing this vehicle. Use of non-genuine parts may shorten the vehicle service life or cause irreparable damage, and failure due to use of non-genuine parts will not be covered by the vehicle warranty.

To purchase genuine Kandi parts, please contact Kandi or an authorized dealership or service center.

### 11.1 Pre-ride Inspection

	<p><b>WARNING</b></p>	<p>Failure to follow the pre-ride inspection procedures could lead to loss of control of the vehicle, and result in damage to the vehicle, serious injury, or death.</p>
---	-----------------------	--

Before attempting to operate this vehicle, use the following checklist to verify that the vehicle is working properly n:

<b>1.</b>	<b>Tires</b>	Check the condition of the tires to ensure that all tires are inflated to the correct pressure, have proper tread depth, and are free of cracks.
<b>2.</b>	<b>Steering wheel</b>	Check that the steering wheel rotates smoothly and is not loose.
<b>3.</b>	<b>Brakes</b>	Check the fluid level, operation, and adjustment for all brakes, including the parking brake.
<b>3a.</b>	<b>Brake pedal</b>	Check the operation of the brake pedal and ensure that it has the proper amount of free play. The brake pedal should move smoothly and should feel firm when the brakes are applied. If the amount of free play is incorrect or there are any other issues with the brake pedal, the vehicle must be inspected and serviced by an authorized dealer or service center.

<b>3b.</b>	<b>Brake fluid leakage</b>	Check for any brake fluid leakage from the brake lines, brake hoses, or brake fluid reservoir by applying the brakes firmly for one minute. If there is any leakage, the vehicle must be inspected and serviced by an authorized dealer or service center.
<b>3c.</b>	<b>Brake fluid level</b>	Check the brake fluid level and add brake fluid when necessary.
<b>3d.</b>	<b>Brake operation</b>	Test the brakes at low speed to make sure that they are working properly. If they do not perform properly, inspect the braking system.
<b>4.</b>	<b>Accelerator pedal</b>	Check that the accelerator pedal operates freely with the correct amount of free play. The accelerator pedal must operate smoothly and fully spring back to its idle position when released. If the accelerator pedal does not perform properly, it must be inspected and serviced by an authorized dealer or service center.
<b>5.</b>	<b>Gear switch</b>	Ensure that the gear switch is working properly.
<b>6.</b>	<b>Lights</b>	Check that the brake light, upper and lower light bars, and their switches are operational.
<b>7.</b>	<b>One-click start switch</b>	Check that the one-click start switch turns on the vehicle and operates normally.

8.	<b>Steering</b>	Check that the steering system operates freely and check for any unusual looseness. Park the vehicle on level ground and turn the steering wheel in both directions. Check for excessive free play, abnormal noises, or a rough feeling. If there are any abnormalities, the vehicle must be inspected and serviced by an authorized dealer or service center.
9.	<b>Loose parts</b>	Visually inspect the vehicle for any damaged components or any loose nuts, bolts, or fasteners. Always check the tightness of the chassis fittings and fasteners before operation. Loose parts must be tightened by a dealer or authorized service center to ensure proper tightening torque.
10.	<b>Safety gear</b>	Ensure that the driver and all passengers are wearing helmets, eye protection, and proper clothing.
11.	<b>Seat belts</b>	Check that seat belts are worn properly and are not frayed or damaged. The latch plate should click securely into the buckle and release when the release button is pressed firmly. Any dirt or mud must be removed to ensure that it does not interfere with seat belt operation. If there are any abnormalities, the vehicle must be inspected and serviced by an authorized dealer or service center.

## 11.2 Periodic Maintenance

Careful periodic maintenance will help keep your vehicle in the safest, most reliable condition. The inspection, adjustment, and lubrication intervals for important components are explained in the chart on the following pages.

**Note:**

Vehicles that are stored for an extended length of time should continue to be maintained according to the monthly maintenance intervals.

Vehicles used in severe conditions, such as dirty, dusty, or wet conditions, must be maintained more frequently in order to remove any water or dirt that could affect grease fittings or other critical components.

Inspect, clean, lubricate, adjust, or replace parts, as necessary.

**Note:**

Inspection may reveal the need for replacement parts. Always use genuine Kandi parts, which are available from your dealer and directly from Kandi.

**Vehicle service and adjustments are critical to the safe operation of this vehicle. If you are not familiar with the procedures necessary to safely service and adjust your vehicle, always have these procedures performed by an authorized dealer or service center.**

### 11.3 Periodic Maintenance Schedule

For items listed with both mileage and months, perform maintenance based on interval that occurs soonest. When performing the monthly service intervals, make sure to also complete items listed in all preceding sections, e.g., 3-month maintenance items should be included during 6-month maintenance.

★ Inspect, clean, adjust      ■ Replace      Ⓣ Tighten

Item	First week	Every 1 month	Every 3 months
	First 100 miles	Every 600 miles	Every 1,800 miles
Gearbox oil			■
Brakes	★	★	
Brake fluid	★	★	
	Replace the brake fluid every 2 years or 12,500 miles.		
Parking brake	★	★	
Tires		★	
Steering wheel	★	★	
Front & rear shock absorbers	★	★	
12V Starting battery	★	★	
	Fully charge the 12V starting battery at least once per month.		
LiFePO4 battery	★	★	
Chassis nuts & bolts	Ⓣ	Ⓣ	







## 11.5 Gearbox Oil

This vehicle is delivered from the factory with the proper amount of 85W-90 gear oil. The gearbox oil should be replaced according to the periodic maintenance schedule included in this owner's manual.

The oil level in the gearbox can only be checked by draining the existing oil and replacing it with the correct type and quantity of gear oil.

### Gearbox Oil Replacement

1. Drive the vehicle for 10 to 15 minutes to warm up the oil in the gearbox.

2. The front gearbox is located behind the front bumper. The drain plug is located on the side of the gearbox facing the passenger side of the vehicle. The location is circled in the image to the right. First, remove the metal pan located below the gearbox and place a container suitable to hold the drained oil under the front gearbox, then drain the oil by removing the drain plug. After the oil has fully drained, reinstall the drain plug.



Front gearbox oil drain plug location  
(Shown with front bumper removed)

3. The rear gearbox is located behind the rear bumper. The drain plug is located on the side of the gearbox facing the passenger side of the vehicle. The location is circled in the image to the right. First, remove the metal pan located below the gearbox and place a container suitable to hold the drained oil under the rear gearbox, then drain the oil by removing the drain plug. After the oil has fully drained, reinstall the drain plug.



Rear gearbox oil drain plug location  
(Shown with rear bumper removed)

4. The front gearbox is located behind the front bumper. The fill plug is located on the side of the gearbox facing the driver side of the vehicle. The location of the front gearbox oil fill plug is circled in the image to the right. The fill plug can be accessed by removing the hood and using a funnel with a transparent flexible extension. Remove the fill plug, then fill the front gearbox with 500ml of 85W-90 gear oil. Once the gear oil is no longer visible in the flexible extension of the funnel, remove the funnel and reinstall the fill plug.

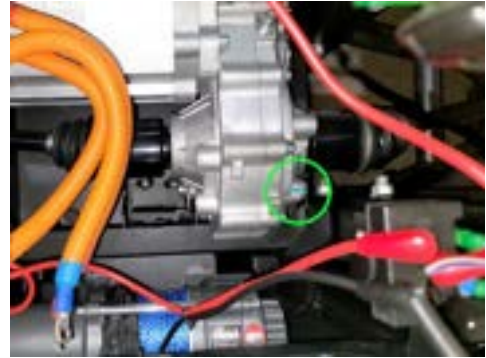

Front gearbox oil fill plug location  
(Shown from above with hood removed)

5. The rear gearbox is located behind the rear bumper. The fill plug is located on the side of the gearbox facing the driver side of the vehicle. The location of the rear gearbox oil fill plug is circled in the image to the right. The fill plug can be accessed by using a funnel with a transparent flexible extension. Remove the fill plug, then fill the rear gearbox with 600ml of 85W-90 gear oil. Once the gear oil is no longer visible in the flexible extension of the funnel, remove the funnel and reinstall the fill plug.



Rear gearbox oil fill plug location  
(Shown from rear driver side wheel well)

**NOTE:** Waste oil must be properly recycled in order to avoid environmental pollution.

## 11.6 Brakes

This vehicle is equipped with front and rear hydraulic disc brakes.



### WARNING

Do not store or use a partial bottle of brake fluid. After using the necessary amount of brake fluid, discard the rest. Brake fluid is hygroscopic, meaning it rapidly absorbs moisture from the air. This lowers the boiling point of the brake fluid, which can cause early brake fade and could result in serious injury.

### Brake Fluid

The brake fluid reservoir is located under the vehicle hood behind the steering wheel. This vehicle uses DOT 3 or DOT 4 brake fluid.

Regularly check the level of the brake fluid in the brake fluid reservoir. If the fluid level is below the lower line, check the brake lines for leaks or cracks.

To check the braking system for fluid leaks, depress the brake pedal and check for excessive travel or a spongy feel.

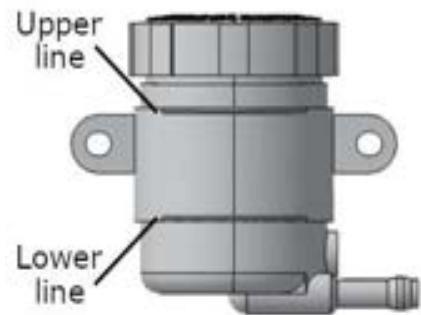

Brake Fluid Reservoir

**If there is a fluid leak, do not attempt to drive the vehicle. Contact an authorized dealer or service center to have the brakes inspected and serviced.**

If there are no leaks, remove the cover and add DOT 3 or DOT 4 brake fluid until the level is between the upper and lower lines.



### CAUTION

Do not use DOT 5 brake fluid in this vehicle.

### Brake Pads

Always check the condition of the brakes before driving the vehicle.

1. Check the brake pads for wear, damage, or looseness.
2. Check that the brake rotor is secure, and its surface is in good condition.

	<p><b>WARNING</b></p>	<p>Failure to check the condition of the brakes before driving the vehicle could result in serious injury or death.</p>
---	-----------------------	---

### 11.7 Tires

Inspect the tires before each trip, and pay particular attention to the following:

1. Check for cracks or air leaks.
2. Check the tread depth. If it is less than 0.16 in. (4 mm), replace the tire.
3. Check the tire pressure. Incorrect tire pressure will affect handling, handling comfort, steering, tire life and traction. Always check the tire pressure before driving the vehicle.



	Maximum cold tire pressure range	Suggested pressure	Tire size
<b>Front tire</b>	10 – 28 psi (69 – 193 kPa)	124 kPa	AT26 x 9-14
<b>Rear tire</b>	10 – 28 psi (69 – 193 kPa)	138 kPa	AT26 x 11-14

### Tire replacement

Ensure that replacement tires are the model and size listed in this manual.

When replacing tires, be sure to use the right tools. Using the wrong tool could damage the lug nuts or rim.

Unless you possess the required skills, experience, and tools, the tires should be replaced by an authorized dealer or service center. Dealerships and service centers have the equipment and expertise required to replace the tire without damage.

Tires that are punctured or cut must be repaired by a professional tire repair shop or a designated service center. If the tire cannot be repaired, it must be replaced.



#### **WARNING**

Driving with worn tires will reduce the traction of the vehicle and increase the risk of accidents that could result in serious injury or death.



#### **WARNING**

Driving this vehicle with improper tire pressure improperly sized tires could lead to a loss of control of the vehicle and could result in serious injury or death.

### 11.8 Storage

Vehicles that are to be stored for a long period of time must be stored and maintained properly. It is not recommended for the vehicle's batteries to be stored for an extended period of time without charging.

1. Thoroughly clean the vehicle, then coat plastic and painted parts with non-abrasive car wax.
2. Remove the 12V starting battery and store it in a cool and dark place.

3. During storage, the 12V starting battery must either be checked once a week and topped off or connected to a battery maintainer that is appropriate for the battery type. Lithium batteries do not need to be connected to a battery maintainer.
4. Keep the tire pressure normal. The vehicle should be driven once a week or elevated on blocks to ensure that the tires do not develop flat spots.
5. When possible, the vehicle should be parked in the shed or garage to minimize contact with dust and water. If the vehicle must be stored outdoors, cover the vehicle with a suitable waterproof cover.

**WARNING**

Do not allow water to come in contact with the batteries or electrical components, as this could cause short circuits, burn electrical circuits or components, cause fire or leakages, or cause other issues that could result in serious injury or death.

**11.9 Resuming Use of the Vehicle**

1. Thoroughly clean the vehicle.
2. Charge the lithium battery. Charge and re-install the 12V starting battery.
3. Conduct the pre-ride inspection.

## 12. Cleaning the Vehicle

### 12.1 Exterior Body Panels

The body panels on this vehicle should be handwashed using an automotive cleaner and a soft sponge or cloth intended for automotive use. A hose with residential water pressure set to a shower or mist setting may be used to rinse the vehicle.

Before spraying the exterior of the vehicle with water, always ensure that the charging socket cover is firmly in place. Be careful not to allow water to come in contact with the power battery, electrical devices, high and low voltage cables, or connectors.



#### **WARNING**

Do not allow water to come in contact with the batteries or electrical components, as this could cause short circuits, burn electrical circuits or components, cause fire or leakages, or cause other issues that could result in serious injury or death.

### 12.2 Seats and Floorboard

The seats and floorboard of this vehicle should be wiped down or spot cleaned with a diluted mild detergent and a soft cloth. Excessive or caked dirt should first be removed by using a soft brush. Detergents should be tested in an inconspicuous location before use to ensure that they are compatible with the seat material.

### 12.3 Wheels and Tires

The wheels and tires may be cleaned with commercially available wheel and tire cleaners. When using these cleaners, ensure that they do not come in contact with the plastic components or body panels, as this could cause irreparable damage.

**NOTE:** Wet brakes have reduced stopping ability. Always test the brakes after washing the vehicle and, if necessary, apply the brakes lightly several times to allow friction to dry out the brake pads.

## 13. Transporting the Vehicle

If this vehicle is transported on an open trailer at speeds in excess of 40 mph, the owner does so at their own risk, and any resulting damage will not be covered under the vehicle warranty. The procedures outlined below are intended to minimize damage to a vehicle transported on an open trailer, but even if these procedures are followed, damage to the vehicle is still possible.



### CAUTION

This vehicle is not designed to be transported at speeds exceeding 40 mph. Transporting this vehicle in an enclosed trailer is highly recommended.

### 13.1 Strap Down the Roof

Use ratchet straps to secure the roof to the frame of the vehicle in multiple locations. Passing the ratchet strap through the hand grip opening at the front of the roof will help keep the ratchet strap from moving during transport of the vehicle.



### CAUTION

Towing this vehicle in an open trailer at speeds exceeding 40 mph without removing the windshield or without strapping down the roof could result in the roof being ripped from the vehicle frame.

### 13.2 Protect the Windshield

Removing the windshield while transporting the vehicle on an open trailer is the best practice. If the windshield is not removed, it must be secured to the vehicle using ratchet straps and covered with a padded protective layer in order to minimize damage caused by objects striking the windshield at high speed.

## 14. Troubleshooting

The following troubleshooting information is intended only as a reference. When necessary, please refer to the information provided in this owner’s manual for inspection, adjustment, and replacement of parts.

### 14.1 Contacting an Authorized Dealer or Service Center

The Kandi America website has a dealer look up engine that includes authorized dealerships, service centers, and stores that sell Kandi vehicles. Please use the contact information to schedule any service requests. Please note that any services provided outside of the warranty process are not covered by Kandi.

### 14.2 Battery (12V) Troubleshooting

The 12V battery is located in the under-seat compartment.

Voltage Reference	
<b>Above 12V</b>	Battery is healthy
<b>6V - 12V</b>	Battery needs recharging
<b>Below 6V</b>	Battery likely needs replacement



#### Above 10V

- If the vehicle doesn’t start, charge the 12V battery
- If the vehicle still doesn’t start, check the 40-amp fuse, if present

#### 6V - 10V

- Recharge battery with Battery Tender or try to jump start
- Monitor the discharge rate, replace the battery if it depletes in 1-2 days

#### Below 6V

- Replace the battery
- Recharging may help, but only temporarily

**Replacing the 12V Battery**

1. Remove the electrical systems cover.
2. Remove the two long bolts with an 8mm wrench
3. Remove the battery hold down brackets
4. Disconnect the battery
  - a. First, disconnect the negative battery terminal
  - b. Then, disconnect the positive battery terminal
5. Remove the battery
6. Place the new battery into position, keeping the cable orientation the same as when the old battery was removed
7. Re-connect the battery terminals
  - a. First, connect the positive battery terminal
  - b. Then, connect the negative battery terminal
8. Secure the battery with the hold down bracket and bolts using an 8mm wrench and 8 lb-ft of torque

### Vehicle Specifications

Length x Width x Height	112.5 x 72.5 x 73 in	286 x 181 x 185 cm
Wheelbase	75 in	190 cm
Ground Clearance	9 in	225 cm
Dry Weight	1720 lbs	780 kg
Vehicle Max Load	2560 lbs	1160 kg
Cargo Box Max Load	441 lbs	200 kg
Max Water Depth	8 in	20 cm
Max Slope	30% Grade	
Front Tire	AT26x9 R14	
Rear Tire	AT26x11 R14	
Front Brakes	Hydraulic Disc Brake	
Rear Brakes	Hydraulic Disc Brake	
Front Suspension	Double Wishbone Independent Suspension	
Rear Suspension	Double Wishbone Independent Suspension	
Front Motor	5kW	
Rear Motor	5Kw	
Battery	150 Ah / 75V	